

ICOM

INSTRUCTION MANUAL

VHF TRUNKED MOBILE RADIO

IC-F1500

UHF TRUNKED MOBILE RADIO

IC-F2500



Icom Inc.

IMPORTANT

READ ALL INSTRUCTIONS carefully and completely before using the transceiver.

SAVE THIS INSTRUCTION MANUAL — This instruction manual contains important operating instructions for the **IC-F1500** and **IC-F2500 TRUNKED MOBILE RADIO**.

FOREWORD

This manual explains the basic operation of the transceiver. Some systems cannot support all of the facilities available on the transceiver. Please ask your system operator or supplier for further information.

EXPLICIT DEFINITIONS

The following explicit definitions apply to this manual.

| WORD | DEFINITION |
|------------------|---|
| ⚠ WARNING | Personal injury, fire hazard or electric shock may occur. |
| CAUTION | Equipment damage may occur. |
| NOTE | If disregarded, inconvenience only. No risk of personal injury, fire or electric shock. |

CAUTIONS

⚠ WARNING! NEVER connect the transceiver to an AC outlet. This may pose a fire hazard or result in an electric shock.

NEVER connect the transceiver to a power source of more than 16 V DC such as a 24 V battery. This connection will ruin the transceiver.

NEVER cut the DC power cable between the DC plug and fuse holder. If an incorrect connection is made after cutting, the transceiver might be damaged.

NEVER place the transceiver where normal operation of the vehicle may be hindered or where it could cause bodily injury.

NEVER allow children to touch the transceiver.

NEVER expose the transceiver to rain, snow or any liquids.

USE supplied microphone only. Other microphones have different pin assignments and may damage the transceiver.

DO NOT connect the transceiver to a power source using reverse polarity. This connection will not only blow fuses but also may damage the transceiver.

DO NOT use or place the transceiver in areas with temperatures below -25°C or above $+55^{\circ}\text{C}$ or, in areas subject to direct sunlight, such as the dashboard.

AVOID operating the transceiver without running the vehicle's engine. The vehicle's battery will quickly run out if transmitting while the vehicle's engine is OFF.

AVOID placing the transceiver in excessively dusty environments.

AVOID placing the transceiver against walls. This will obstruct heat dissipation.

AVOID the use of chemical agents such as benzene or alcohol when cleaning, as they may damage the transceiver surfaces.

BE CAREFUL! The transceiver will become hot when operating continuously for long periods.

TABLE OF CONTENTS

| | |
|---|--------------|
| IMPORTANT | i |
| EXPLICIT DEFINITIONS | i |
| CAUTIONS | i |
| TABLE OF CONTENTS | ii |
| 1 PANEL DESCRIPTION | 1-3 |
| ■ Front panel | 1 |
| ■ Function keys | 2 |
| ■ Function display | 3 |
| 2 OPERATION | 4-11 |
| ■ Turning power ON | 4 |
| ■ Making a call | 4 |
| ◇ DESPATCHER CALL | 4 |
| ◇ DESPATCHER CALL (Send a status message) | 5 |
| ◇ DIRECTORY CALL | 5 |
| ◇ DIRECTORY CALL (Send a status message) | 4 |
| ◇ QUEUE MEMORY CALL | 7 |
| ◇ DELETE QUEUE MEMORY CALL | 7 |
| ◇ PROGRESS MESSAGES | 8 |
| ■ Receiving a call | 9 |
| ■ Other functions | 11 |
| 3 SET UP MENU | 12 |
| 4 CONNECTION AND INSTALLATION | 13-15 |
| ■ Rear panel and connection | 13 |
| ■ Unpacking | 14 |
| ■ Mounting | 15 |
| ■ Separate | 15 |
| 5 OPTIONS | 16 |

■ Front panel

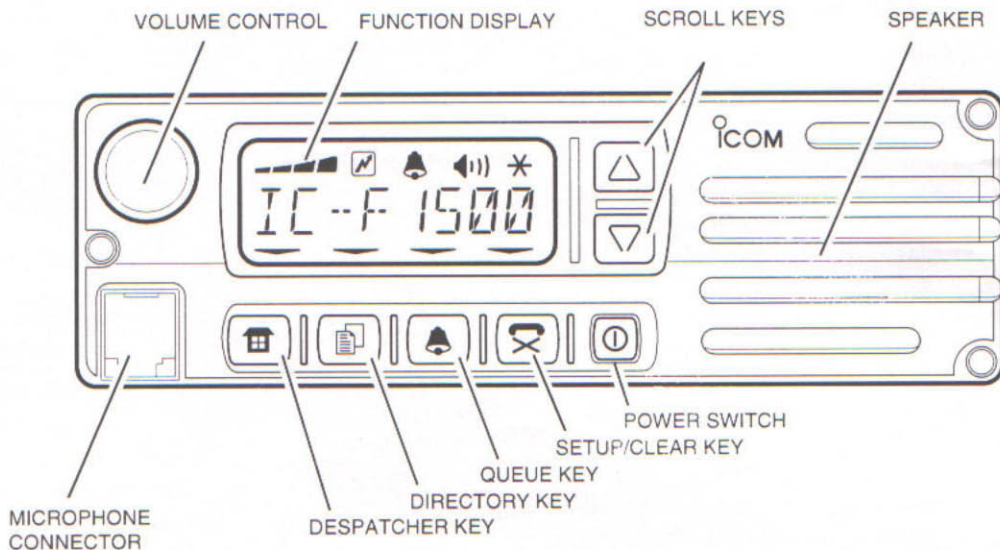

VOLUME CONTROL

Adjust the audio output level.

- Minimum audio level (when setting at maximum counter clockwise) is pre-programmed.

POWER SWITCH

Turns power ON and OFF.

- Push and hold the key to turn the power ON and OFF.

MICROPHONE CONNECTOR

Connect the supplied microphone here.

NEVER connect other microphones. The pin assignments may be different and the transceiver may be damaged.

MICROPHONE

The supplied microphone has a PTT switch and a hanger hook.

- The HOOK switch function is available when the microphone is hung on or released from the microphone hanger. (See *SET UP MENU*, page 12)

Function keys

NOTE: When an operation is initiated, any subsequent keys should be pushed within a pre-programmed time or the display will return to the "READY" prompt.

**DESPATCHER KEY**

- Push once to select despatch call.
- Push once again to select a status code. Use / keys to select a status code.
- When 'PTT calls despatcher function' is pre-programmed, no pushing is required.

**DIRECTORY KEY**

- Push once to select a directory memory. The following individual calls may be memorised in the directory memory and can be selected with / keys.
 - public telephone number calls (PABX or PSTN).
 - In fleet calls and Inter fleet calls.
 - group calls.
 - emergency or priority call.
- Push once again to select a status message. Use / keys to select a status message.

1 PANEL DESCRIPTION





QUEUE KEY

- Push once to select a queue memory.
- Push once again to delete all or a selected unanswered queue call.
- Push and hold to turn the 'Call back function' ON/OFF. (See *CALL BACK FUNCTION*, page 11)



SETUP/CLEAR KEY

- Push to send the selected call.
Push ,  or  in advance.
- When 'PTT calls dispatcher function' is pre-programmed, no pushing is required for the despatch call.
- Push to send an 'End of call' code when the call is completed.
- When "READY" on the display, push and hold to enter 'SET UP MENU'.
(See *SET UP MENU*, page 12)



SCROLL KEY



- Scrolls the following information when the corresponding display is selected.
 - Directory memories when directory menu is selected.
 - Queue memory number when queue menu is selected.
 - Status messages.
- Select ON/OFF or adjust a level when 'SET UP MENU' is selected. (See *SET UP MENU*, page 12)

Function display



RECEIVING SIGNAL INDICATOR

- Shows a communication link condition.
- To maintain a connection, at least the first two segments of the indicator must be displayed.



TRANSMIT INDICATOR

- Appears while pushing and holding the Press-To-Talk switch (PTT switch) on the microphone.
- Traffic mode indicator () should appear in advance.



CALL ABSENCE INDICATOR

- Blinks when any entries in your call queue have not been answered yet.



TRAFFIC MODE INDICATOR

- Indicates that the call has been set up and the radio is in conversation mode. The [PTT] can be used to make a voice transmission.



ACTIVATED KEY INDICATOR

- Appears when the key under this indicator is activated.
- Blinks when the 'Call back function' is activated. (See *CALL BACK FUNCTION*, page 11)

Turning power ON

- ① Push [①] to turn the power ON.
 •Power-up alert tone sounds and the following displays appear in sequence.

Icom Inc

Opening message may differ depending on the pre-setting.

123/4567

Prefix number / Fleet individual
(123) / number (4567)

890

Unit number (890)

- A three-digit number is for a large fleet and two-digit number is for small a fleet.

- The following indications appear after above.

READY

Your location is in the trunked system area. You can use the system.

NO SRVCE

You are out of the service area or the system is down. You can not use the system.

NOTE: Even if "NO SRVCE (no service is available)" appears on the display, the transceiver keeps searching for the system control signal. Please wait until "READY" appears on the display.

Making a call

◇ DESPATCHER CALL

- ① Push [☒] while "READY" appears on the display.
 - "DESPATCH" appears and a beep will be heard.
- ② Push [☒] to call the despatcher while "DESPATCH" appears.
 - 'PTT calls despatcher function' is available depending on the pre-setting. (See page 11)
- ③ Wait until "CONNCTED" appears.
 - Direct despatcher call function' is available depending on the pre-setting.
- ④ You can start a conversation.
 - A call limit timer starts counting down to the permitted time limit.
 - Warning beeps 10 sec. before the limit is reached and the call is disconnected automatically.
- ⑤ Push [☒] to end the conversation when the call is completed (or wait "R-CLEAR" appears).
 - The display changes from "L-CLEAR" (or "R-CLEAR") to "READY" prompt.

DESPATCH

CALLING

Transceiver is calling the despatcher now.





CONNCTED

Immediate call can start.

TIME 056

2 OPERATION

◇ **DESPATCHER CALL (Send a status message)**

- ① Push  while "READY" appears on the display. "DESPATCH" appears and a beep sounds.
- ② Push  once again to select a status menu.
- ③ Push  /  to select a status message.
- ④ Push  to send the desired status message to the despatcher while it is selected on the display.
- ⑤ "CALLING" appears on the display, then "OK" appears for a moment.
- ⑥ "READY" appears again.



Some status messages may differ depending on pre-setting.

- The transceiver has 32 status messages.
- The following messages are commonly used in any network:
 - "CALL REQ" (call request - please call me back)
 - "CALL CAN" (call cancell - cancell call me back)
- Messages may differ depending on pre-setting.
- If you want to cancell the status "CALL REQ" which you sent to the despatcher, you should send the status "CALL CAN" to the despatcher again.





◇ **DIRECTORY CALL**

 Some systems cannot support all of the facilities available on the transceiver. Please ask your system operator or supplier for further information.

The transceiver has up to 41 directory memories.

Directory memories have the following call capabilities.

- PABX (private addressed branch exchange) numbers.
- PSTN (public switched telephone network) numbers.
- In-Fleet call: calling a unit number in your fleet.
- Inter-Fleet call: calling a unit number out of your fleet.
- Emergency call: calling a specified emergency station.
- Priority call: having a higher priority than other calls.
- Group call: two types of group calls are available.
 - Conference call: allows a group discussion. All the involved parties can transmit.
 - Broadcast call: allows a message to be sent without interruption. Only the originator can transmit and disconnect.

- ① Push  while "READY" appears on the display.
- ② Push  /  to select a directory memory.
- ③ Push  while desired directory appears.
- ④ "CALLING" appears and interval beep sounds.



Some directory number may differ depending on pre-setting.

- ⑤ "CONNECTED" and  appear on the display. You can start a conversation. The call limit timer starts counting down to the permitted time limit.



Immediate call can start.





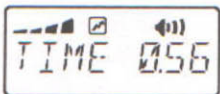

• When other progress messages appear on the display, please wait or follow the instructions.

(See *PROGRESS MESSAGES*, page 8)

- A warning beep sounds 10 sec. before the limit is reached and the call is automatically disconnected.
- ⑥ Push  to end the conversation (or wait "R-CLEAR" appears).
 - The display changes "L-CLEAR" (or "R-CLEAR") to "READY" prompt.



◇ *DIRECTORY CALLING (Send a status message)*

- ① Push  while "READY" appears on the display.
 - A directory memory appears and a beep sounds.
 - Some directory memories may differ depending on pre-setting.
- ② Push  /  to select directory memory.
- ③ Push  when the desired directory appears on the display.
- ④ Push  /  to select a status message.
- ⑤ Push  when the desired status message appears on the display.
- ⑥ "CALLING" appears on the display, then "OK" appears for a moment.
- ⑦ "READY" appears again.



Some directory memories or status messages may differ depending on pre-setting.



2 OPERATION

◇ QUEUE MEMORY CALL

- The transceiver can memorise up to 15 logs of incoming calls when you do not answer.
- "CALLS" plus the number of calls appears on the display in such cases.
- The call absence indicator (📞) blinks until you answer all calls or delete all memories.

NOTE: Be aware that a queue memories are erased when the transceiver is turned OFF.

- ① Push (📞) to select a queue memory.

- "Q" numbers and the called station's identity appears.
- The latest call is indicated.

- ② Push (📞) to select queue memories when two or more calls have been received.
- ③ Push (📞) to answer the selected queue.

- ④ After "CALLING" appears you can start a conversation in the same manner as for despatcher or directory calling.

- The number of memorised calls decrements when you answer a call.



One call is memorised in the queue memory.



Unit number 88 is queued in memory number 1.

◇ DELETE QUEUE MEMORY CALL

- You can delete all queue memories at once or one by one without answering.
- All delete or partial delete depends on the pre-setting.

- ① Push (📞) when "CALLS" plus number of calls appears on the display.



- ② Push (📞) to select queue memory to be deleted.

- ③ Push and hold (📞) for more than 2 sec. to delete.



- When the all delete function is pre-set, all queue memories are deleted at once.

Select Q1 to delete.

- ④ Push (📞) to return to the "CALLS" prompt.



- When no calls are in the queue memory, the display returns to the "READY" prompt.

- ⑤ Push (📞) once again to return to the "READY" prompt.

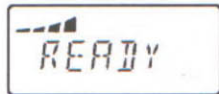

◇ **PROGRESS MESSAGES**

The display can show a number of messages indicating progress conditions during a call.

When the following progress messages appear on the display, please wait for a while or follow the instructions.

| DISPLAY | DESCRIPTION |
|----------------|---|
| ABORTING | Your call is aborted. Please try again. |
| CALLING | The transceiver is calling the destination. |
| CALLBACK | Your call is memorised in the destination's queue. Please wait for a replay. |
| CALL FAIL | Your calling was failed. Please try again. |
| DIVERTED | Your call has been diverted to another address. |
| EMERGENCY CALL | An emergency call has been sent. |
| ENGAGED | The called station is busy. Please call later. |

| DISPLAY | DESCRIPTION |
|--------------------|--|
| INVALID | The number you called is wrong. You cannot use this number any more. |
| NO REPLY | The called station has not replied to your call. Please try later. |
| PRIORITY CALLING | A priority call has been sent. |
| QUEUED | Your call has been received by the system. Please wait until the system calls the destination. |
| RINGING | The called station is ringing. |
| SYSTEM BUSYOUT | The system cannot accept your call at the moment. |
| TIME OUT CALL FAIL | Your call has timed out. Please try again. |

■ Receiving a call

When an incoming call is received, the transceiver may emit a beep or make a ringing sound like a telephone (this function depends on the system) and the called station's identity will be displayed.

• Display example



In fleet call



Group call



Inter fleet call



Call from PSTN



Call from PABX

◇ RECEIVING AN IN FLEET CALL

- ① When an in fleet call is received, the transceiver may emit a beep tone and connect immediately.
- ② The called station's identity appears on the display.
- ③ When pushing and holding [PTT], you can start a conversation.
 -  appears while pushing [PTT].
- ④ A call limit timer starts counting down to a pre-set time



Fleet number "88" calls you.

limit.



- ⑤ Push  to end the conversation (or wait "R-CLEAR" appears).

- The display changes "L-CLEAR" (or "R-CLEAR") to "READY" prompt.



Call limit timer starts counting down.

• When a call is not answered

- ① When a call is not answered, the incoming call is memorised in the queue memory.
 - "CALLS" and call number appears and the call absence indicator () blinks.
- ② Push  to return to the "READY" prompt.
- ③ The call absence indicator () blinks until you answer or delete the queue memories. (See *QUEUE MEMORY CALLING*, page 7)



One call is memorised in the queue memory.



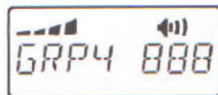

◇ RECEIVING A GROUP CALL

- ① When a group call is received, the transceiver emits a beep and connects immediately.

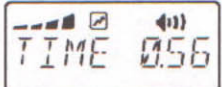

Fleet number "888" is calling group number "4".

- ② The calling fleet number and "GRP" appears on the display.
- ③ When the call is a conference call, you can start a group discussion.
 -  appears while your transceiver transmits.
 - When the call is a broadcast call, you cannot transmit. Only the originator can transmit.
- ④ The call limit timer starts counting up to the called station's pre-set time limit.

- ⑤ Push  to end the call and return to "READY" prompt.

◇ RECEIVING AN INTER FLEET OR A TELEPHONE CALL



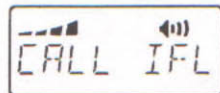

- ① When an inter fleet call, PABX call or PSTN call is received, the transceiver may make a ringing sound like a telephone. (This function depends on your system.)
- ② "CALL IFL", "CALL PBX" or "CALL TEL" appears on the display instead of identity numbers.



Inter fleet call



Call from PABX

- ③ Push  or push and release [PTT] to connect the call.
 - Push and hold  for more than 2 sec. to reject the incoming call.
- ④ You can start a conversation.
 -  appears while your transceiver transmits.
- ⑤ The call limit timer starts counting down to a pre-set time limit.
- ⑥ Push  to end the conversation (or wait "R-CLEAR" appears).
 - The display returns to the "READY" prompt.

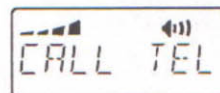

Call from PSTN

◇ RECEIVING A STATUS CALL FROM WITHIN YOUR FLEET

- ① When an incoming status call is received, the transceiver may emit a beep.
- ② The display then shows the called station's identity and the status message alternately.
- ③ Push  to return to the "READY" prompt.

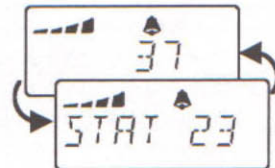

e.g. Called station's identity 37 and the incoming status message 23 appears alternately.

Others functions

Some systems cannot support all of the facilities available on the transceiver. Please ask your system operator or supplier for further information.

◆ CALL BACK FUNCTION

- Automatically stores incoming calls when you are not in your vehicle or you cannot answer immediately.
- Automatically sends a "CALL BACK" message to the called station.
- This function depending on pre-setting.
- Other functions work the same as "READY" prompt.

- ① When "READY" appears, push and hold  until "CALLS 0" appears.



- The activated key indicator  starts to blink.

- ② When an incoming call is memorised, Call absence indicator  starts to blink and call numbers is incremented.



One call is stored in the queue memory.

- ③ Push and hold  until "READY" appears to exit a call back function.

◆ QUERY STATUS

- A special status message to remotely obtain a destination's status message left in the transceiver.

◆ PTT CALLS DESPATCHER FUNCTION

- The 'Despatcher' and 'set up' key operation sequence can be performed via the PTT switch.
First push of PTT : Selects despatcher stand-by.
Second push of PTT : Transmits the despatcher call.

◆ DIVERT CALL





- A special directory call to your system when you want to change your operating transceiver to another.

◆ DIVERT 3rd PARTY CALL

- This is the same as above, except the directory call request is made by someone other than yourself (a 3rd party).

Set up menu

Some systems cannot support all of the facilities available on the transceiver. Please ask your system operator or supplier for further information.

- ① Push and hold  while "READY" or "NO SRVCE" appears until the set up menu appears on the display.
- ② Push  several times to select the desired set up menu.
- ③ Push / to set ON, OFF, CLR or ANS, etc. in the menus.
- ④ Push and hold  until "READY" or "NO SRVCE" appears on the display to exit the set up menu.

Menu list

LAMP

20 The backlight turns ON at maximum brightness for 20 sec. when any switch is pushed.

5 The backlight turns ON at maximum brightness for 5 sec. when any switch is pushed.

ON Turns the backlight to maximum brightness.

OFF Turns the backlight to minimum brightness.

ALT

00000 Alert tone level (max).

0 _ _ _ _ Alert tone level (min).

BEP

00000 Beep tone level (max).

0 _ _ _ _ Beep tone level (min).

HOOK

ON When a call is received, picking up the microphone will connect the call. And, putting the microphone back in its holder will end the call automatically.

ANS When a call is received, picking up the microphone will connect the call. Putting the microphone back in its holder will not end the call.

CLR When the microphone is replaced on the hanger during a call, the radio will initiate a local-clear and return to the idle condition.

OFF No hook operation available. The microphone can be picked up and replaced at any time without affecting the call.

HORN

ON Turn the pre-programmed 'Horn Honk' function ON.

OFF Turn the pre-programmed function OFF.

LCD

5 LCD brightness up (max).

1 LCD brightness down (min).

■ Rear panel and connections

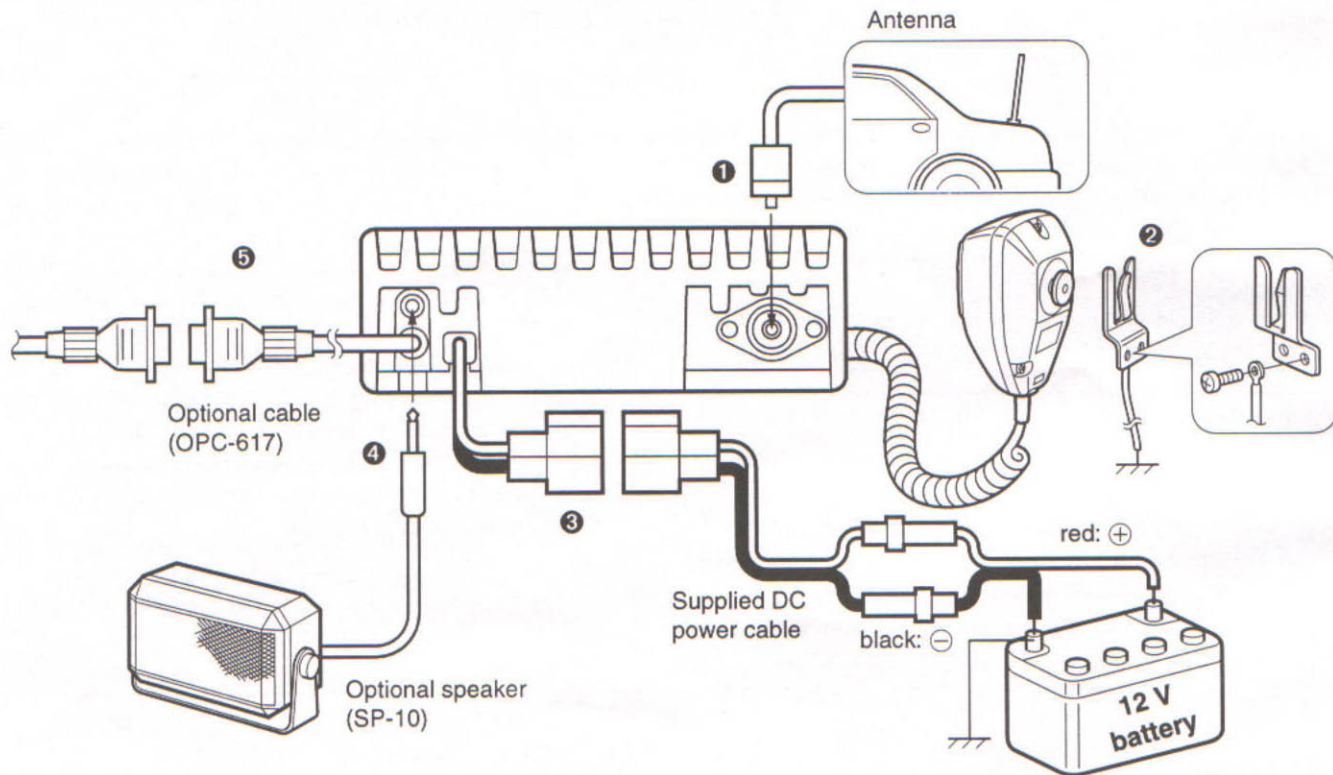

1 ANTENNA CONNECTOR

Connects to an antenna. Ask your dealer about antenna selection and optimum installation locations.

2 MICROPHONE HANGER

Connects the supplied microphone hanger to the vehicle's ground for the hanger function when hanging or releasing the microphone.

3 DC POWER RECEPTACLE

Connects to a 12 V DC battery. Pay attention to polarities. **NEVER** connect to a 24 V battery. This could damage the transceiver.

4 EXTERNAL SPEAKER JACK

Connect a 4–8 Ω external speaker, if desired.

5 OPTIONAL CABLE (OPC-617)

Connect a horn drive control, LCD backlight control, audio, etc.

OPTIONAL CABLE PIN ASSIGNMENT

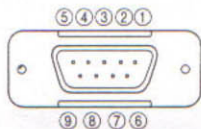

- | | |
|------------------------|------------------------|
| ① LCD backlit cont. IN | ⑥ Horn drive cont. OUT |
| ② NC | ⑦ GND |
| ③ NC | ⑧ GND |
| ④ NC | ⑨ GND |
| ⑤ PTT control IN | |

Unpacking

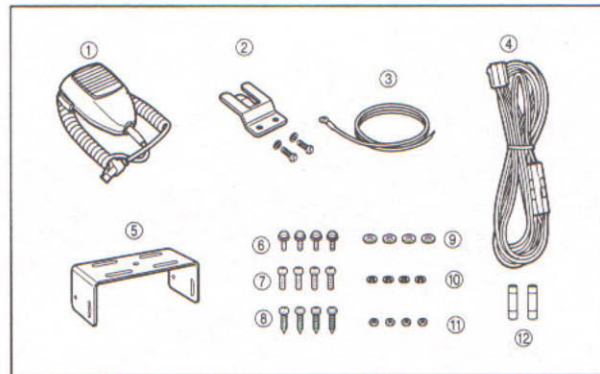

| | |
|--|-------|
| ① Microphone (EM-99)..... | 1 |
| ② Microphone hanger and screw set..... | 1 set |
| ③ Microphone cable | 1 |
| ④ DC power cable (OPC-345) | 1 |
| ⑤ Mounting bracket | 1 |
| ⑥ Bracket bolts | 4 |
| ⑦ Mounting screws (M5x12) | 4 |
| ⑧ Self-tapping screws (M5x20)..... | 4 |
| ⑨ Flat washers..... | 4 |
| ⑩ Spring washers | 4 |
| ⑪ Nuts..... | 4 |
| ⑫ Fuses (15 A) | 2 |

4 CONNECTION AND INSTALLATION

■ Mounting

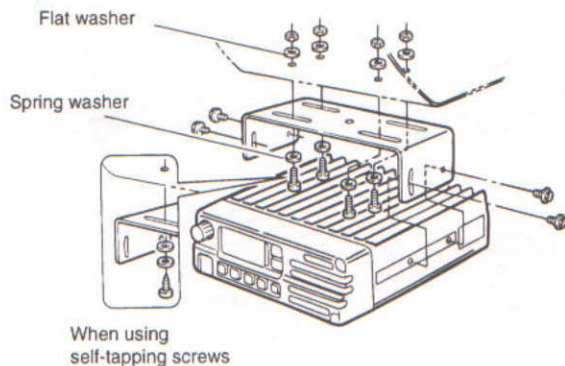

■ Separation

- ① Separate the front panel from the transceiver main unit using an allen-wrench (1/32 in).
- ② Connect the optional OPC-609 cable to the both front and main unit attachments (fig 1 and 2).
 - Remove the rear plate of the attachment.
 - Use the supplied screw to connect a cable lug.
 - For the main unit attachment, attach to the main unit using supplied screws, in advance.
- ③ Attach the front panel and attachment with the 3 removed allen socket bolts (fig. 3)

•Separation (using RMK-1)

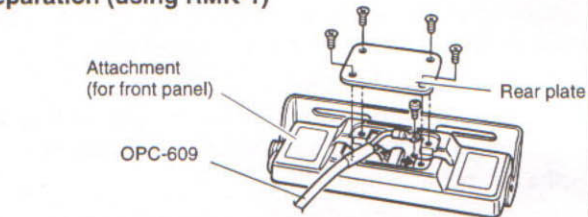
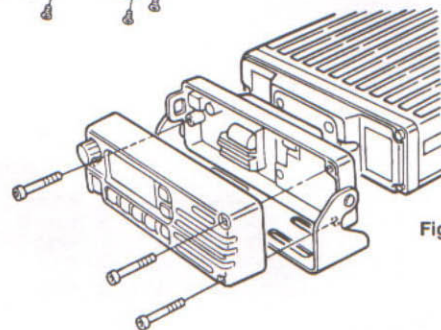
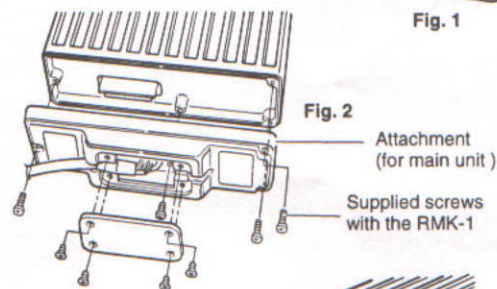
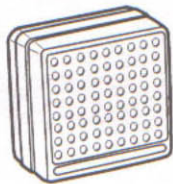

Fig. 1



EXTERNAL SPEAKERS



SP-5

Large speaker for good audio quality.

Input impedance: 4 Ω

Max. input power: 5 W

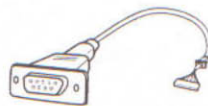

OPC-617 ACC CABLE

Allows external terminal connection.

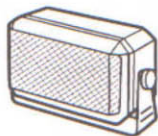

SP-10

Compact and easy-to-install.

Input impedance: 4 Ω

Max. input power: 5 W

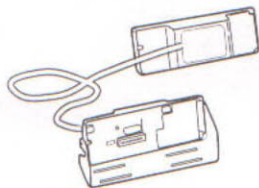

RMK-1 SEPARATION KIT and OPC-609 SEPARATION CABLE

Allows you to separately install the transceiver main unit and front panel for easy installation and operating convenience.

Cable length: 1.9 m

Count on us!

A-5403S-1EX
Printed in Japan
Copyright © 1996 by Icom Inc.

Icom Inc.
6-9-16 Kamihigashi, Hirano-ku, Osaka 547 Japan